



Hot Water Generation – Steam/Water Single Wall

Digital-Flo® Semi-Instantaneous Steam/Water Shell and Tube Heat Exchanger

Model DFS3540BS

DFS3540BS is a complete pre-piped single wall semi-instantaneous steam/water shell and tube heater. The assembly includes a properly sized shell and tube heat exchanger with a Digital Recirculating Valve (DRV40) and SAGE™ hot water system monitoring and reporting tool.

Digital technology provides enhanced water temperature control accuracy and enhanced user safety in a single control component. SAGE™ technology to remotely view and adjust set point, data log and monitor inlet hot, inlet cold/return and mixed water outlet with multiple BAS interface options.

Operational Specifications

- +/-2°F water temperature control at points of use 25' downstream during demand
- +/-2°F water temperature control during zero system demand "idling" periods
- 2°F minimum valve inlet to outlet temperature requirement (system recirculation temperature loss)
- Automatic shutoff of hot water flow upon cold water inlet supply failure
- Automatic shutoff of hot water flow in the event of a power failure
- Programmable set point range of 81-158°F (27-70°C)
- Programmable 1st level hi/lo temp alarm display
- Programmable temperature error level for double safety shutdown.

Technical Specifications

- Maximum steam pressure: 15 PSIG constant.
- Maximum domestic pressure: 150 PSI
- Minimum recirculation flow: 5 GPM
- Design conditions: Domestic-28 GPM at 100°F delta T using 15 PSIG steam; 35 GPM at 120 °F Setpoint using Blend Formula
- Complete assembly Lead Free Compliant
- All domestic side valve fittings and isolation valves, strainers, inlet/return check valves, inlet system blend and return thermometers pre-piped.
- DRV – all wetted parts 316 stainless steel
- DRV to be UL Listed
- Heat exchanger shall be U-bend 3/4" copper tubes expanded into 304 stainless steel tube sheets
- Water pipe of type L copper
- Fabricated carbon steel frame with machine grade enamel paint
- 120 volt power supply required
- Secondary (double) safety shut-off valve included
- SAGE™ Hot Water System Monitoring and Reporting Tool

Connectivity

SAGE™ – Hot water system monitoring and reporting tool.

For Building Automation Systems – Interface module available with Building Automation System (BAS) specific ProtoCessor cards for system which operate on the Modbus, BACnet, or Lonworks protocols.

For the Web – Dashboard operable smart, hot water system monitoring and reporting software that works seamlessly as it analyzes data to track behavior and performance ensuring full compliance with ASHRAE, VA and World Health Organization hot water system safety guidelines.

'BS' Model Nomenclature refers to - Building System hardware used with SAGE™

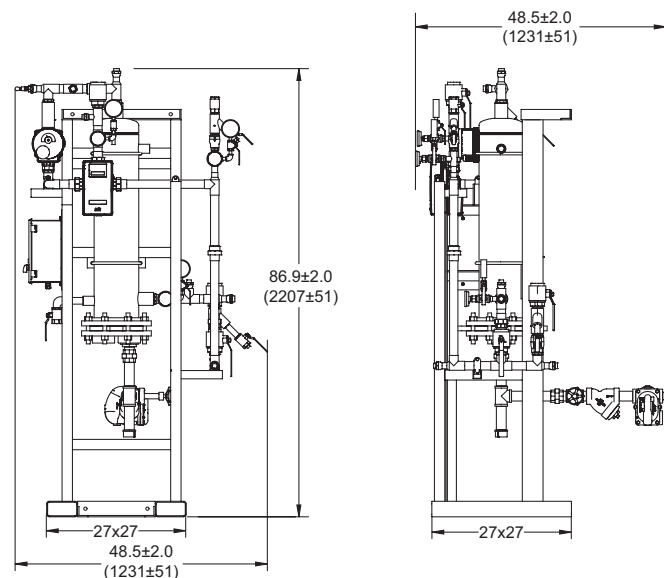
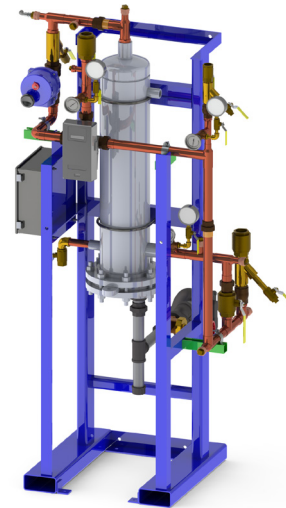

Designs, materials, weights and performance ratings are approximate and subject to change without notice. Visit armstronginternational.com for up-to-date information.