

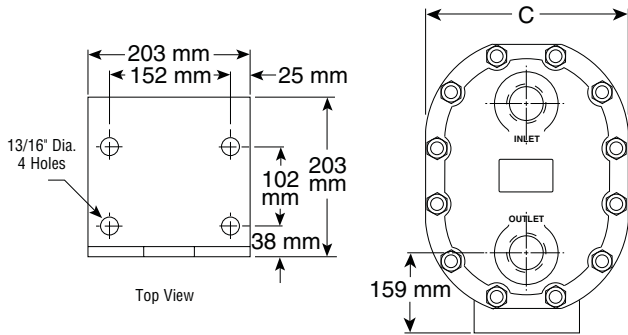

LS & MS Series Ultra-Capacity Float & Thermostatic Steam Traps

Cast Steel for Horizontal Installation, with Thermostatic Air Vent
For Pressures to 31 bar...Capacities to 127 000 kg/h

Steam Trapping and Steam Tracing Equipment



LS and MS Floor Mounting Bracket

Table ST-142-1. LS and MS Series Side Inlet, Side Outlet Trap

Model No.	LS & MS		
Pipe Connections	50	65	80
"B" Height	508		
"C" Width (not shown on drawing)	387		
"D" Bottom to ϕ	106		
"H" Face-to-Face (screwed & SW)	508		
"HH" Face-to-Face (flanged PN40*)	553	557	563
"M" ϕ to ϕ	287		
"S" Gauge Glass Width	95,2		
"T" Gauge Glass Height	305		
Weight in kg (screwed & SW)	131,5		
Weight in kg (flanged PN40*)	137,5	140,5	143,5

Dimensions in mm

* Other flange sizes, ratings and face-to-face dimensions are available on request. All models are CE Marked according to the PED (97/23/EC).

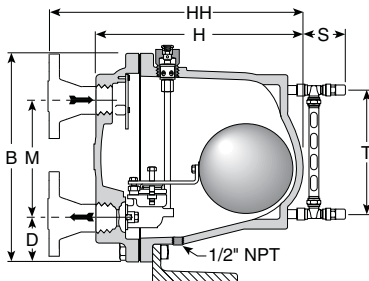

Series LS, F&T Shown

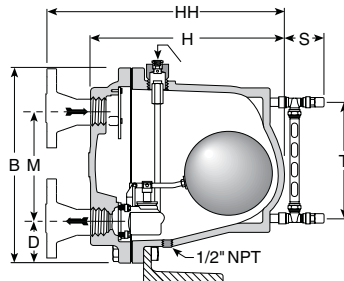

Series MS, CC Shown

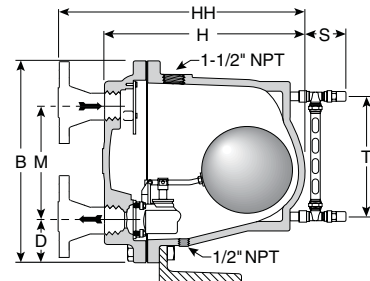

Series MS, LD Shown

Description

The simple yet rugged cast steel construction of the LS & MS Series Ultra-Capacity F&T steam traps offers long, trouble-free service. All floats, valves and seats, and lever mechanisms are constructed of stainless steel.

The integral thermostatic air vent is a balanced-pressure phosphor bronze bellows caged in stainless steel. It is designed especially for heavy-duty industrial applications where highly efficient, uninterrupted service is essential. This balanced-pressure air vent will respond to the pressure-temperature curve of steam at any pressure from zero to 17 bar. Thus – up to 17 bar – air is vented at slightly below steam temperature.

Maximum Operating Conditions

Maximum allowable pressure (vessel design)†:

Model LS:	31 bar @ 338°C
Model MS:	31 bar @ 338°C

Maximum operating pressure:

Model 30-LS:	2 bar saturated steam
Model 100-LS:	7 bar saturated steam
Model 150-LS:	10 bar saturated steam
Model 250-LS:	17 bar saturated steam
Model 250-MS:	17 bar saturated steam
Model 450-LS:	31 bar saturated steam
Model 450-MS:	31 bar saturated steam

Maximum back pressure: 99% of inlet pressure

Maximum operating temperature bellows: 217°C

Note: For pressures above 17 bar, the thermostatic vent should be removed and only a CC or LD version should be used.

† May be derated depending on flange rating and type.

Connections

- Screwed BSPT and NPT
- Socketweld
- Flanged DIN or ANSI (welded)

Materials

Body and cap:	ASTM A216 WCB
Internals:	All stainless steel – 304
Valve(s) and seat(s):	Stainless steel
Drain plug:	Carbon steel
Thermostatic air vent:	Stainless steel and bronze with phosphor bronze bellows, caged in stainless steel

Options

- Integral vacuum breaker 10 bar maximum. Add suffix VB to model number.
- No internal thermostatic air vent for liquid drainer service. Add suffix LD to model number.
- Integral flash release for syphon drainage service. Add suffix CC to model number.
- Armored gauge glass 17 bar @ 218°C
- LS and MS Series available with floor mounting bracket. Consult factory.

Specification

Float and thermostatic steam trap, type ... in cast steel, with thermostatic air vent. Maximum allowable back pressure 99% of inlet pressure.

All dimensions and weights are approximate. Use certified print for exact dimensions. Design and materials are subject to change without notice.

LS & MS Series Ultra-Capacity Float & Thermostatic Steam Traps

Cast Steel for Horizontal Installation, with Thermostatic Air Vent
For Pressures to 31 bar...Capacities to 127 000 kg/h

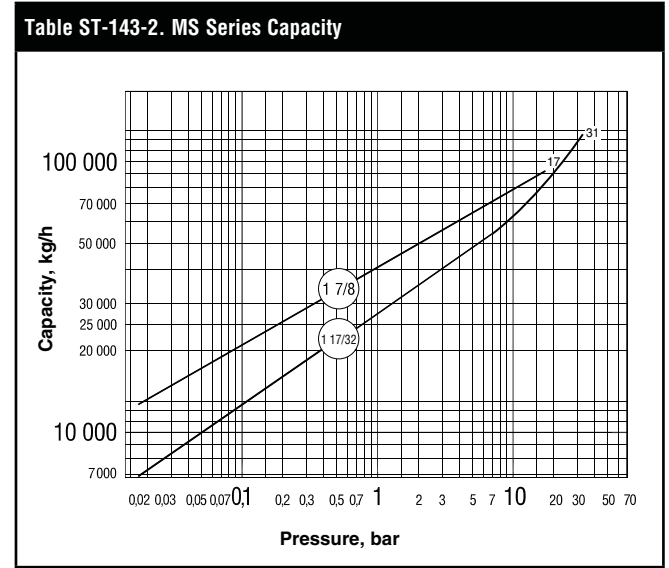
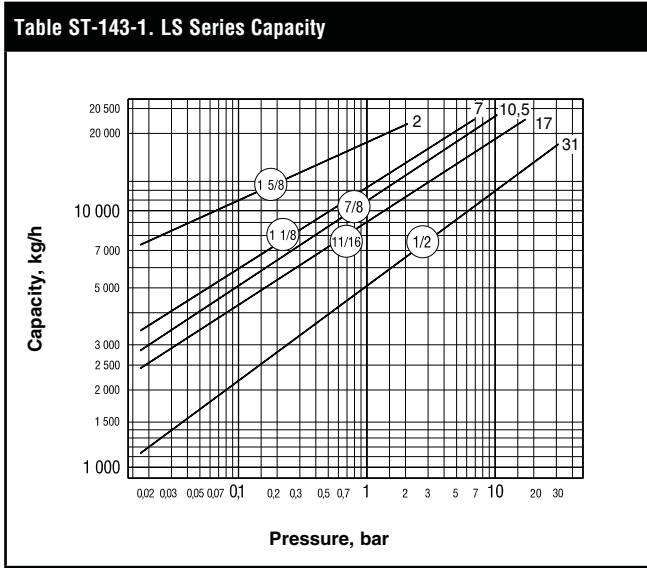

Special Configurations

Condensate controller with flash release for syphon drainage and/or cascade service. The condensate controller (CC) configuration was developed especially to meet very large capacity needs in applications where condensate must be lifted from the drain point to the trap. Under such conditions – often referred to as syphon drainage – the reduction in pressure that occurs when condensate is elevated causes a portion of the condensate to flash into steam. Ordinary traps, unable to differentiate between flash steam and live steam, close and impede drainage.

The LS & MS Series condensate controllers (CC) are equipped with a fixed, restricted orifice near the top of the body to bleed off the flash steam (and all air present). This permits the trap to function properly on condensate.

Liquid drainer with back vent for exceptionally high capacity drainage of liquid from gas under pressure. The liquid drainer (LD) configuration was developed to meet very large capacity needs in draining water and other liquids from air or other gases under pressure. To prevent air or gas binding, the access port in the top of the body serves as a back vent connection to the equipment being drained. For capacity data, see pages LD-381 and LD-404 or consult your Armstrong Representative.

Installation Notes

Under conditions where the load may approach the maximum capacity of the trap, it is recommended that the size of the discharge line be increased one size as close to the trap cap as is practical.

When LS and MS Series units are used in severe service conditions or at pressures exceeding 2 bar, use an anchoring bracket or other supportive measures to minimize stress on piping.

Ultra-Capacity LS and MS Series units **MUST BE WARMED UP** in the proper sequence and gradually. Recommended warm-up rate not to exceed 55°C/8 minutes.

See your Armstrong Representative.

Vacuum Breaker – 3/8" and 1/2" NPT

Many times, condensate will be retained ahead of steam traps because of the presence of a vacuum. To break a vacuum, air must be introduced into the system by means of a vacuum breaker.

For maximum protection against freezing and water hammer in heating coils under modulated control, for example, vacuum breakers are recommended in conjunction with freeze protection devices.

How to Order

Pressure	Model	Connection Size	Option
100	LS	10	VB
30 = 2 bar 100 = 7 bar 150 = 10.5 bar 250 = 17 bar 450 = 31 bar	LS	8 = DN50 10 = DN65	VB = Vacuum Breaker LD = Liquid Drainer CC = Condensate Controller G/G = Gage Glass
250 = 17 bar 450 = 31 bar	MS	12 = DN80	

Table ST-143-3. Vacuum Breaker (dimensions in mm)

Size	1/2" NPT	3/8" NPT
"B" Pipe Connections	3/8"	1/4"
"H" Height	30	28
"D" Width	22 Hex	17 Hex

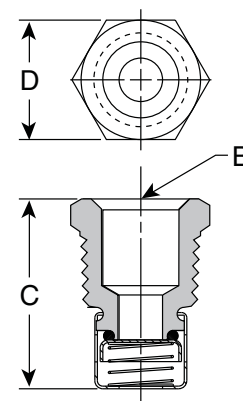

All dimensions and weights are approximate. Use certified print for exact dimensions. Design and materials are subject to change without notice.