



# Hot Water Generation – Boiler Water/Water Double Wall

## Digital-Flo® Boiler Water/Water Plate and Frame Heat Exchanger

### Model DF65WEDW50

DF65WEDW50 is a complete pre-piped instantaneous boiler water/water heater. The package includes a properly sized double wall plate and frame heat exchanger packaged with a Digital Recirculating Valve (DRV50).

Digital technology provides enhanced water temperature control accuracy and enhanced user safety in a single control component.

### Operational Specifications

- +/-2°F water temperature control at points of use 25' downstream during demand
- +/-2°F water temperature control during zero system demand "idling" periods
- 2°F minimum valve inlet to outlet temperature requirement (system recirculation temperature loss)
- Automatic shutoff of hot water flow upon cold water inlet supply failure
- Automatic shutoff of hot water flow in the event of a power failure
- Programmable set point range of 81-158°F (27-70°C)
- Programmable thermal disinfection mode
- Programmable 1st level hi/lo temp alarm display
- Programmable temperature error level for double safety shutdown.

### Technical Specifications

- Maximum boiler water temp: 160°F
- Maximum domestic pressure: 150 PSI
- Maximum boiler pressure: 150 PSI
- Minimum recirculation flow: 10 GPM
- Design conditions: Domestic-65 GPM at 100°F delta T Boiler side- 160°F at 30 deg delta T.
- Complete package Lead Free Compliant
- All domestic side valve fittings and isolation valves, strainers, Inlet/return check valves, inlet, system blend and return thermometers, pre-piped. Boiler side piping/fittings supplied by others.
- DRV – all wetted parts 316 stainless steel
- DRV to be UL Listed
- Stainless steel liners on plate and frame exchanger
- Plates shall be single wall field replaceable 316 stainless steel
- Water pipe of type L copper
- Fabricated carbon steel frame with machine grade enamel paint
- 120 volt power supply required
- Secondary (double) safety shut-off valve included

### Connectivity

**SPCO Relay Outputs** – Relay which is energized during operation.

**LCD Display** – Provides information on set point, delivered temperature, error messages and alert conditions.

**RS485 Serial Port** – Connects the DRV to either Modbus or BrainScan®. (See DF65WEDW50BS for package with BrainScan®.)

**Modbus** – DRV can be configured to communicate directly with Building Automation Systems (BAS) using Modbus protocols.

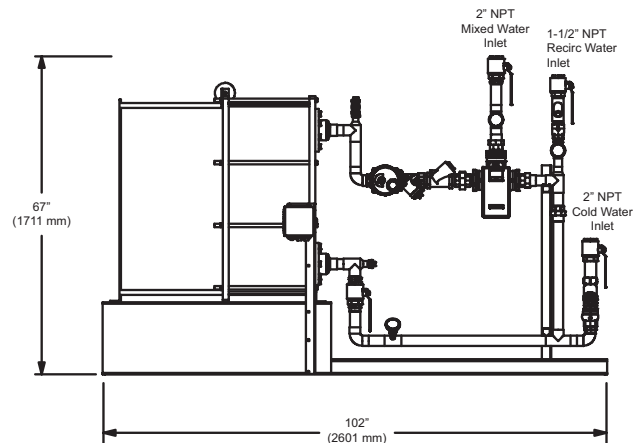
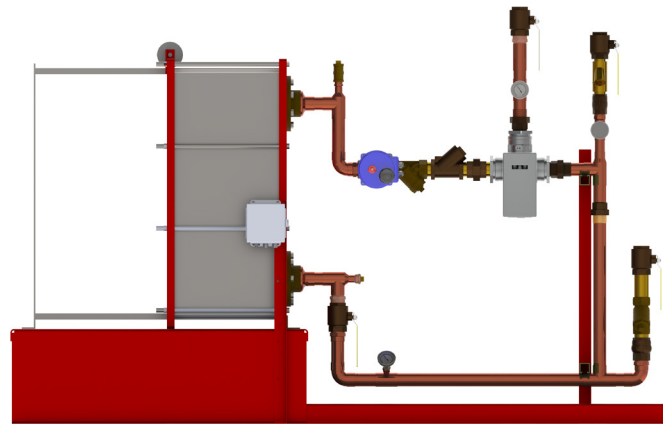

Designs, materials, weights and performance ratings are approximate and subject to change without notice. Visit [armstronginternational.com](http://armstronginternational.com) for up-to-date information.